

WATERPROOF LIMIT SWITCHES

TYPE 83 777 BASED ON SENSITIVE MICROSWITCH

This range of limit switches satisfies applications which require lightweight miniature devices without sacrificing mechanical and electrical performance.

They are particularly well suited to severe environments such as: Aerospace, Armaments, Marine, etc. The plungers for this range of limit switches are equipped with an ice-scraper seal.

BASIC SENSITIVE MICROSWITCH 83 141 002

Simple plunger

Characteristics			
Nominal current	10 VDC	A	0.01
Resistive	30 VDC	A	4
	220 VAC	A	1
Inductive L/R = 0.005 s	30 VDC	A	2
	220 VAC	A	0.5
Service life at nominal current	operations - min.	50 000	
Dielectric strength between connections and ground	V	1 500	
Dielectric strength between connections	V	1 000	
Insulation resistance (at 500 VDC)	MΩ	100	
Voltage drop at 1 A*	V	0.06	
Operating temperature	°C	-55 to +125	
Shock resistance	G/ms	50/11	
Vibration resistance	G/Hz	10/20 → 2 000	

* for flying leads, add 0.1 V / meter.

Connections

Wires: 0.38 mm² - 0.50 m long
 - Output parallel to device axis,
 - Output perpendicular to device axis

Connector: type HE 301
 - NFC 93422
 - MIL.C 26482.G series 1
 - VG 95328

Seal

We guarantee that our products are sealed to level IP 66.

Electrical diagram

Plunger in released position

- 1 pole

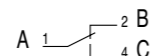

- 2 pole

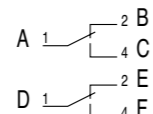

- 3 pole

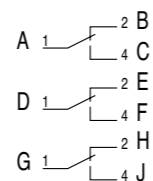

Criteria

Connection wires	parallel
	perpendicular
Connector	HE 301 1H 10 6P
	HE 301 1H 12 10P

Characteristics

Max. Operating force	N
Min. Release force	N
Max. Total travel force	N
Max. Pre-travel	mm
Max. Differential travel	mm
Min. Overtravel	mm
Weight (with wires)	g

Dimensions (mm)

- (107) Stop washer width 0.8
- (112) Locating pin
- (117) Free position
- (118) Nuts h. 2.5 - 15 on flat
- (119) Nuts h. 3 - 21 on flat
- (130) Pin h.2

Panel cut-out

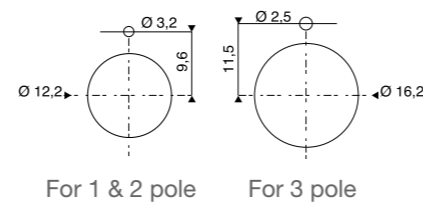

1 pole	2 pole	3 pole	1 pole	2 pole	3 pole	1 pole	2 pole	3 pole
83 777 021	83 777 321	83 777 621	83 777 011	83 777 311	83 777 611	83 777 031	83 777 331	83 777 631
•	•	•	•	•	•	•	•	•

60	60	60	60	60	60	60	60	60
10	10	18	10	10	18	10	10	18
150	150	150	150	150	150	150	150	150
1.2	1.2	1.2	1.2	1.2	1.2	1.2	1.2	1.2
0.2	0.5	0.5	0.2	0.5	0.5	0.2	0.5	0.5
3.2	3.2	5.5	3.2	3.2	5.5	3.2	3.2	5.5
30	41	80	30	41	80	34	34	73

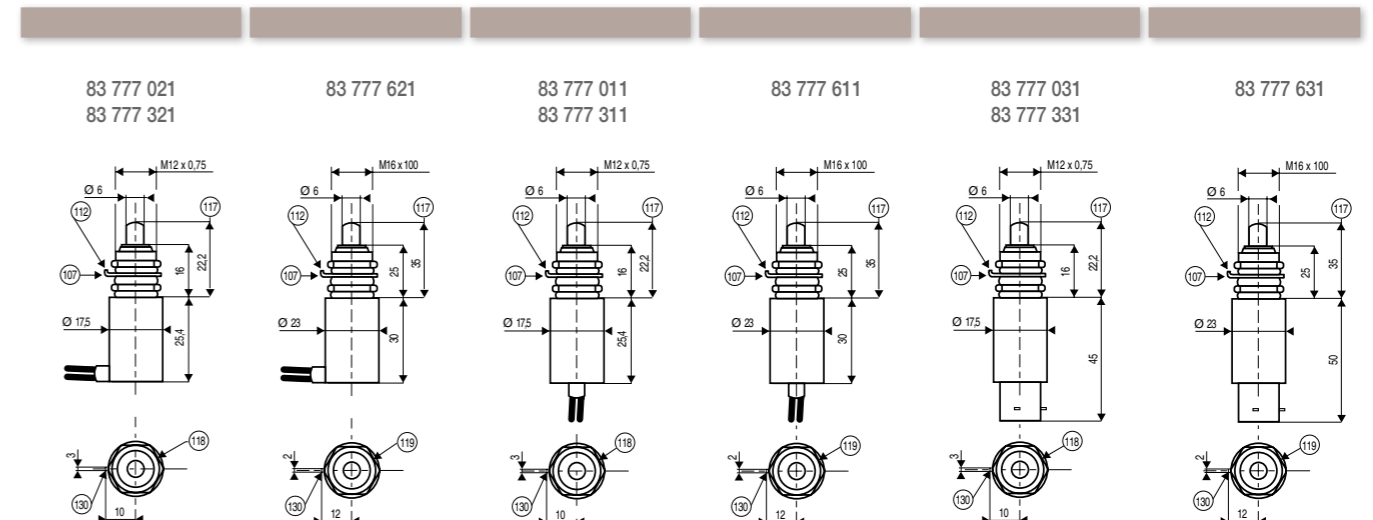

WATERPROOF LIMIT SWITCHES

TYPE 83 778 BASED ON SENSITIVE MICROSWITCH

This range of limit switches satisfies applications which require lightweight miniature devices without sacrificing mechanical and electrical performance.

They are particularly well suited to severe environments such as: Aerospace, Armaments, Marine, etc. The plungers for this range of limit switches are equipped with orientable roller.

BASIC SENSITIVE MICROSWITCH 83 141 002

Plunger with orientable roller in 45° steps

Characteristics			
Nominal current	10 VDC	A	0.01
Resistive	30 VDC	A	4
	220 VAC	A	1
Inductive L/R = 0.005 s	30 VDC	A	2
	220 VAC	A	0.5
Service life at nominal current	operations - min.	50 000	
Dielectric strength between connections and ground	V	1 500	
Dielectric strength between connections	V	1 000	
Insulation resistance (at 500 VDC)	MΩ	100	
Voltage drop at 1 A*	V	0.06	
Operating temperature	°C	-55 to +125	
Shock resistance	G/ms	50/11	
Vibration resistance	G/Hz	10/20 → 2 000	

* for flying leads, add 0.1 V/ meter.

Connections Electrical diagram

Wires: 0.38 mm² - 0.50 m long
 - Output parallel to device axis,
 - Output perpendicular to device axis

Plunger in released position

- 1 pole

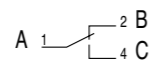

Connector: HE 301 type
 - NFC 93422
 - MIL.C 26482. G series 1
 - VG 95328

- 2 pole

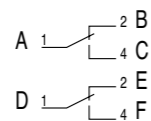

- 3 pole

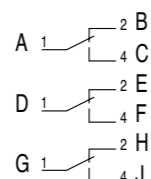

Seal

We guarantee that our products are sealed to level IP 66.

Criteria

Connection wires	parallel
	perpendicular
Connector	HE 301 1H 10 6P
	HE 301 1H 12 10P

Characteristics

Max. Operating force	N
Min. Release force	N
Max. Total travel force	N
Max. Pre-travel	mm
Max. Differential travel	mm
Min. Overtravel	mm
Weight (with wires)	g

Dimensions (mm)

- (107) Stop washer 0.8 thick
- (112) Locating pin
- (117) Free position
- (120) Nuts h. 2.5 and 6 - 15 on flat
- (121) Nuts h. 3 and 6 - 21 on flat
- (122) Roller Ø 9.6 - Width. 3
- (123) Roller Ø 12.7 - Width. 3
- (130) Pin h. 2

Panel cut-out

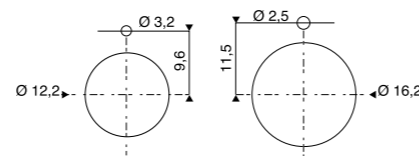

For 1 & 2 pole For 3 pole

1 pole	2 pole	3 pole	1 pole	2 pole	3 pole	1 pole	2 pole	3 pole
83 778 021	83 778 321	83 778 621	83 778 011	83 778 311	83 778 611	83 778 031	83 778 331	83 778 631
•	•	•	•	•	•	•	•	•

60	60	60	60	60	60	60	60	60
10	10	18	10	10	18	10	10	18
150	150	150	150	150	150	150	150	150
1.2	1.2	1.2	1.2	1.2	1.2	1.2	1.2	1.2
0.2	0.5	0.5	0.2	0.5	0.5	0.2	0.5	0.5
3.2	3.2	5.5	3.2	3.2	5.5	3.2	3.2	5.5
37	46	87	37	46	87	40	40	80

Dimensions (mm)

