

COIL DATA:

MODEL BR230 PART NUMBER	BR230-20()-6V	BR230-78()-12V	BR230-290()-28V	BR230-890()-48V	BR230AC-()-115V (Note 3)
NOMINAL COIL VOLTAGE	6 VDC	12 VDC	28 VDC	48 VDC	115 VAC
MAXIMUM COIL VOLTAGE	8 VDC	15 VDC	29 VDC	59 VDC	122 VAC
PULL IN VOLTAGE (MAX @ +125°C)	4.5 VDC	9 VDC	18 VDC	36 VDC	90 VAC
DROP OUT VOLTAGE (MAX)	1.8 VDC	3.5 VDC	5.1 VDC	11 VDC	5 - 30 VAC
COIL RESISTANCE ± 10% @ 25°C	20 OHMS	78 OHMS	290 OHMS	890 OHMS	I = 0.04 AMPS

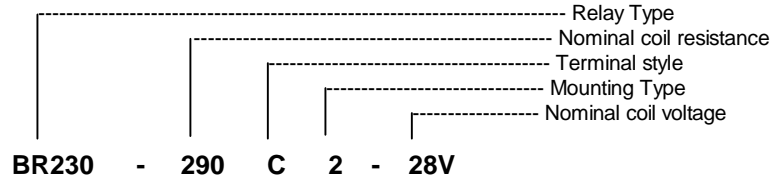

SCHEMATIC

TERMINAL VIEWS

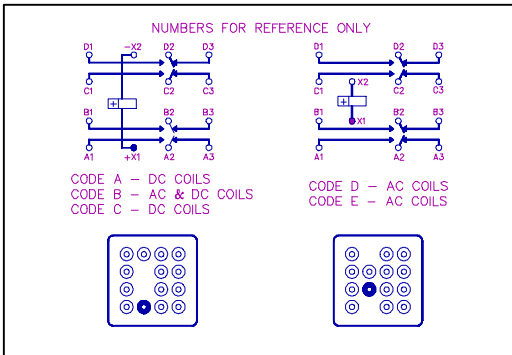

TERMINAL STYLES

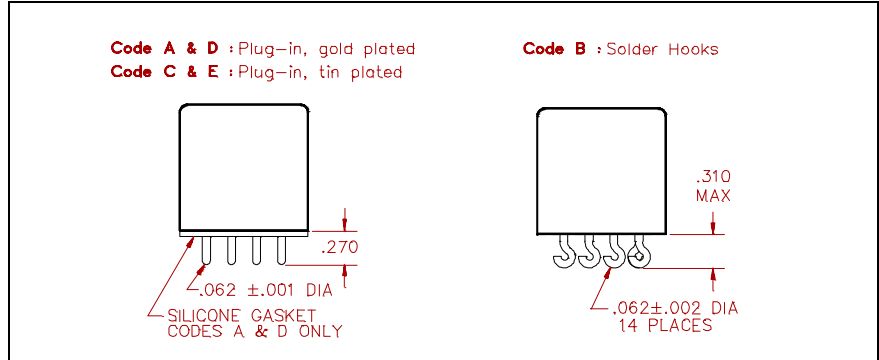

MOUNTING CODES

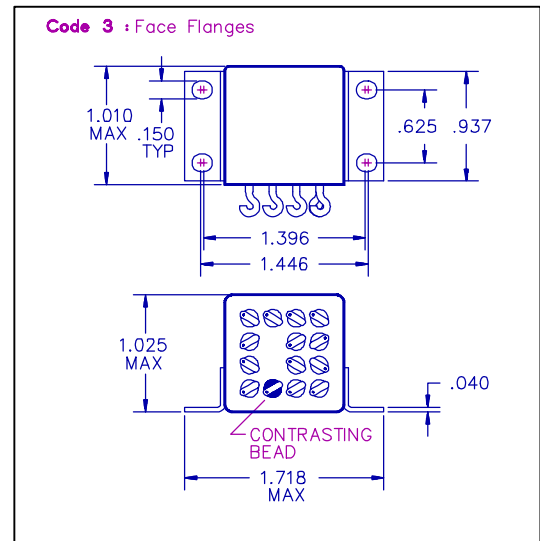
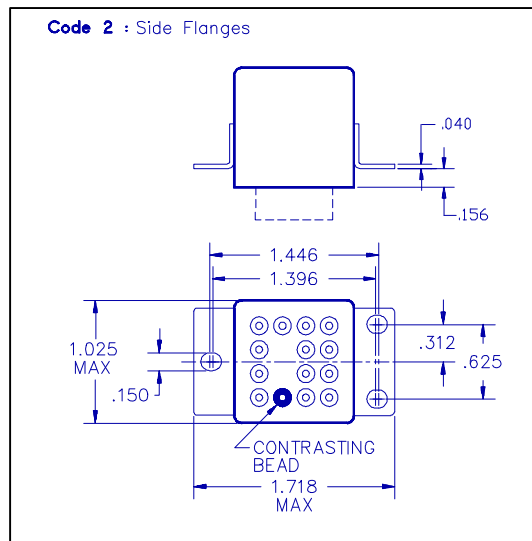
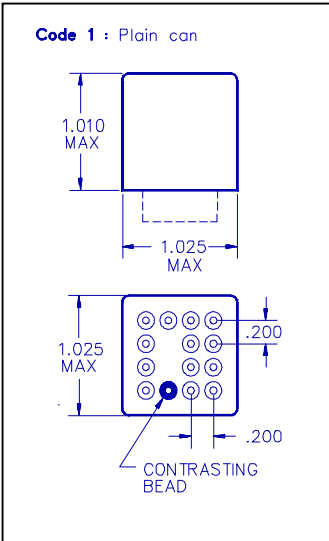

GENERAL NOTES

- Unless otherwise specified, all tests made at nominal coil voltages, @ 25°C.
- For special coil variations, switching configurations, terminals styles and mounting types, consult the factory.
- Unless otherwise specified, tolerances on decimal dimensions are ± .010".
- Specifications contained herein are subject to change without notice.