

# MSC

## SERIES 600 COMPUTER - GRADE SWITCH

CATALOG LISTING  
**600**

REF.

MASTER SPECIALTIES CO., 1640 Monrovia, Costa Mesa, California 92627

301

Technical drawings of various Series 600 switches. Each drawing includes a top view, a side view with dimensions, and a color-coded label.

- SERIES 600 INDICATOR:** Dimensions: .750 DIA MAX TYP, .45 TYP, .055 MAX, .900 MAX TYP, .45. Label: SERIES 600 INDICATOR (Yellow).
- 2 AMP SLIDE SWITCH:** Dimension: 1.25 MAX. Label: 2 AMP SLIDE SWITCH (Orange).
- 5-10 AMP SNAP ACTION SWITCH:** Dimensions: .830 MAX (height), .830 MAX (width), 1.75 MAX (length). Label: 5-10 AMP SNAP ACTION SWITCH (Blue).
- NO BOUNCE SWITCH:** Dimension: 2.50 MAX. Label: NO BOUNCE SWITCH (Yellow).
- SNAP-IN ADAPTER:** Dimension: 1.00 MAX. Label: SNAP-IN ADAPTER (Green).
- LED:** Dimensions: .930 MAX (height), .850 MAX (width), 1.100 MAX (length), .06 TYP (width of LED). Label: LED (Red).

MSC YOU CAN'T DO BETTER.

NOTES

BY	DESCRIPTION	DATE	BY	REL.
	REVISIONS			

1.000M MK.20  
UNLESS OTHERWISE SPECIFIED  
DIMENSIONS ARE IN DECIMAL INCHES  
DRAWN BY: J.E. Thompson  
CHECKED BY: J.E. Thompson  
RELEASE



MSC's Series 600 is the most versatile switch in its class, offering a configuration for virtually any switch requirement. Series 600 switches offer performance features and reliability not available in any other line of low-cost, computer-grade lighted pushbutton switches.

Designed especially for use in data systems and controlled industrial environments, these switches assure long-term premium performance at remarkably low cost. MSC has made them easy to specify, and easy to install in any system. Series 600 includes a number of features not available in other low-cost, computer-grade units.

Series 600 switches are available with different mounting configurations, and many choices of pushbutton sizes, styles, and colors. Switch configurations include from one to six poles, in Forms A, B, and C.

Switches rated for 2 amperes have sliding, bifurcated contacts. Bifurcated contacts multiply reliability up to 40 times, compared with single-point contacts. The sliding design provides a full-length, self-cleaning action, and reduces contact bounce to a fraction of that produced by snap-action contacts. Additional benefits of sliding contacts include reduced EMI/RFI, and more reliable dry circuit switching.

Switches rated at 5 or 10 amperes use snap-action contacts for fast, positive transfer of higher currents. Most Series 600 units have Underwriters' Laboratories approval.

Series 600 offers a wide choice of switch actions: momentary, alternate, and indicating alternate.

The following pages clearly define the details — feature by feature — and provide a simple guide to specifying any of the Series 600 options. The guide will make it easy to satisfy your pushbutton switch and indicator requirements.



**600 31 A5 C2 D1 F3 J1(A) L3 N12 ON**

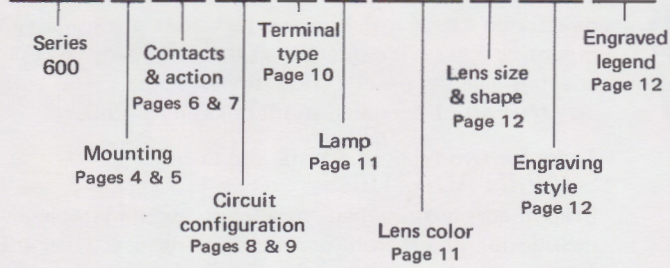

The pages of this catalog describe each characteristic offered in a Series 600 switch. To exactly define the switch you need, simply select the code that identifies your choice for each characteristic. The selected codes, written together, become the part number you will use to order the switch. For example:

A sample part number appears at the top of each page, emphasizing the code you are selecting from that page.

The picture below shows the eight characteristics you can specify, and the page of this catalog that describes each characteristic.

See page 15 for ordering information.

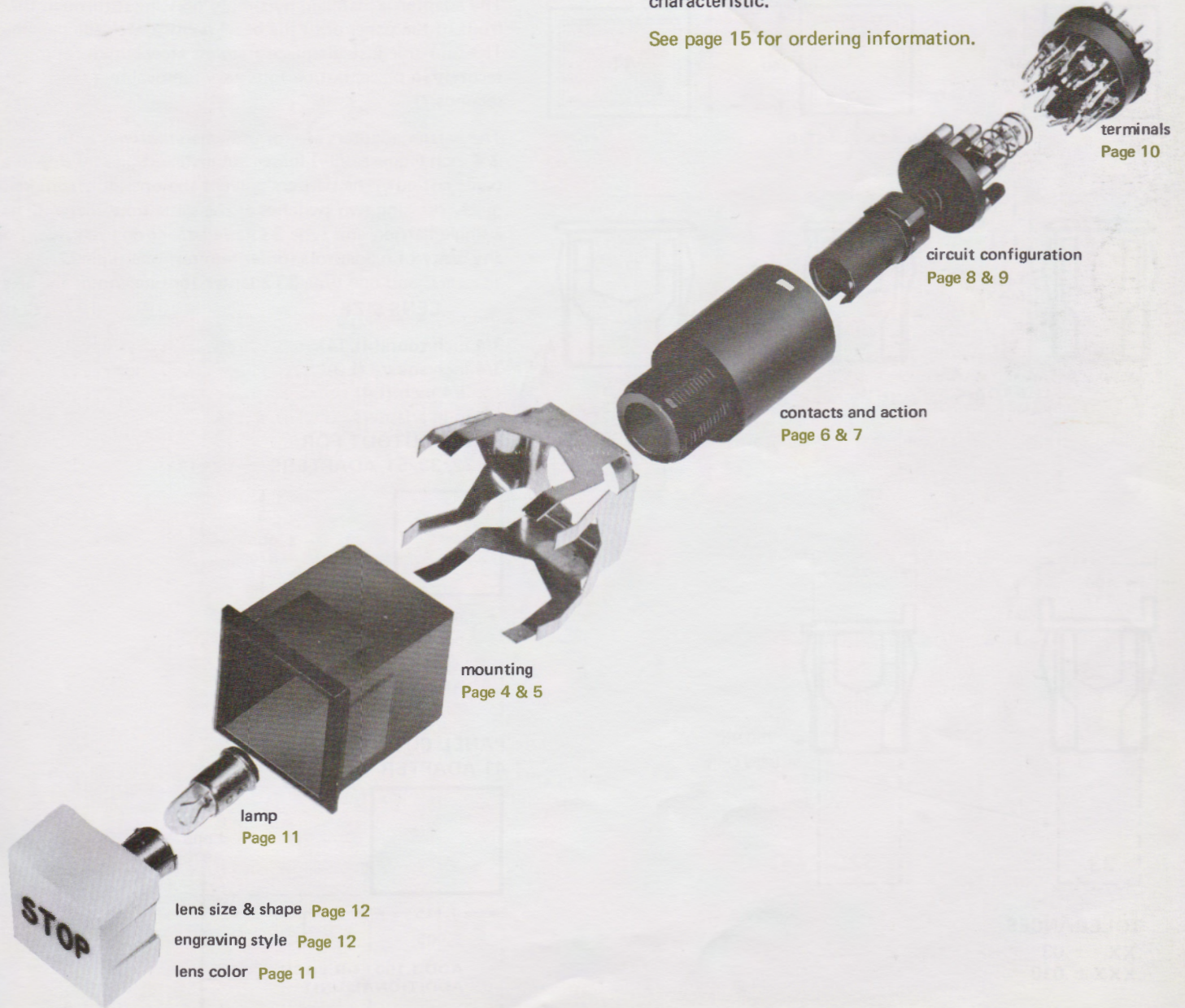





PANEL THICKNESS: 1/16" TO 1/4"

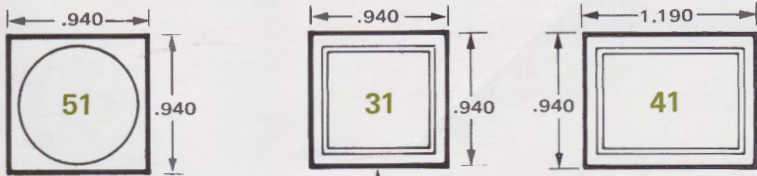
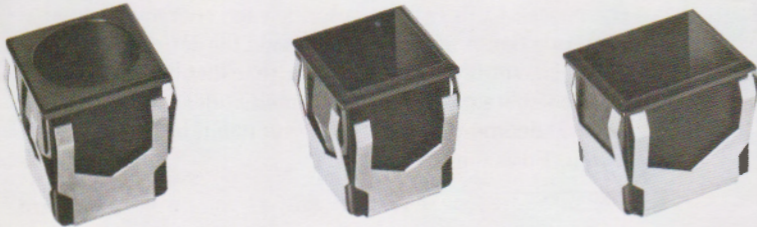

BLACK PLASTIC

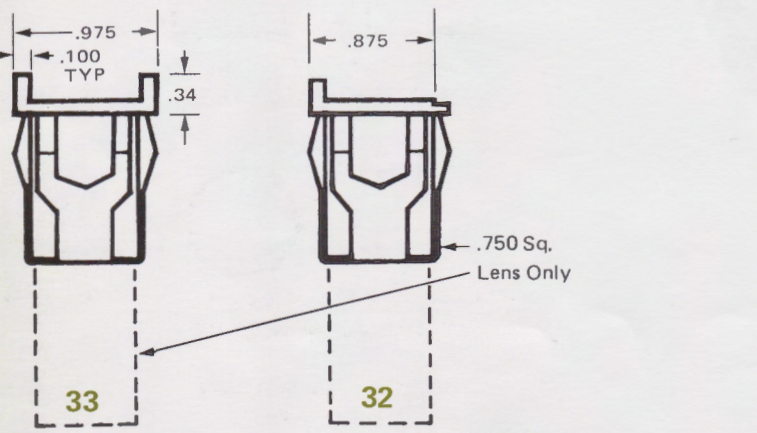
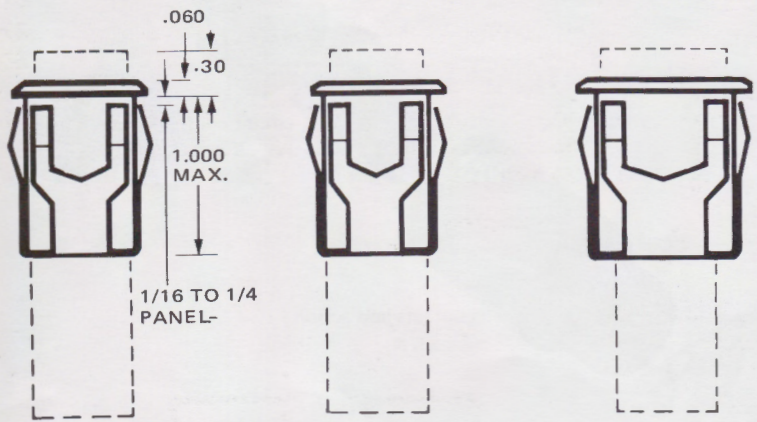

The basic switch has a threaded collar and is furnished with a self-locking spanner nut for mounting the switch directly on a subpanel. However, adapters are available for mounting any switch directly on the front panel. These adapters give the panel a clean, finished appearance and save the cost of designing and fabricating a subpanel.

There are two types of adapter mountings.

**SNAP-IN ADAPTERS**

Snap in adapters are made of a tough nylon material and include an integral front-panel bezel. The glossy black finish gives your panel a high-quality, custom appearance.

The adapter is installed by simply pressing it through the front of the panel until the bezel is flush with the panel. The four-sided, single-piece stainless steel clip holds it securely in place, but permits easy removal in a few seconds.

The barrier adapters are for use when switches with 3/4 inch (square only) lenses are installed side by side in a single panel cut-out. The barriers prevent the operator from inadvertently pressing two switches at the same time. Type 32 has a single barrier, and type 33 has a barrier on each side. For any array of n adapters, order n-minus-one type 32 adapters, and one type 33 adapter for one end of the array.

LENS SIZE	CODE
3/4 inch round (L14)	51 <sup>1</sup>
3/4 inch square (L3)	31 <sup>1</sup>
1 x 3/4 inch (L4)	41 <sup>1</sup>

<sup>1</sup> snap-in adapters

**PANEL CUTOUT FOR 31, 32, 33, 51 ADAPTERS**

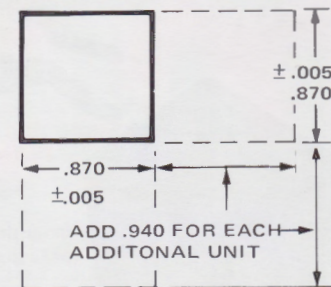

**PANEL CUTOUT FOR 41 ADAPTER**

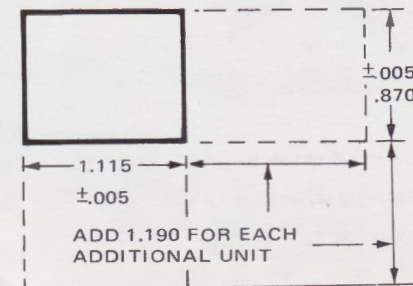

**TOLERANCES**

- .XX ± .03
- .XXX ± .010





PANEL THICKNESS: 1/32" TO 3/16"

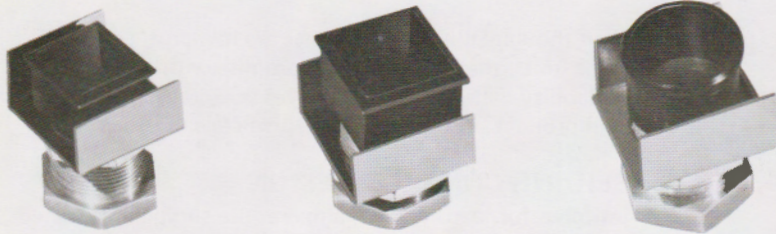

**HARD-MOUNT ADAPTORS**

Hard-mount adaptors mount in the panel before the switches are installed on them. They have the same glossy black nylon bezel as the snap-in adaptors.

The bezel is locked tightly against the panel front by the pressure of a U-bracket against the back of the panel. Pressure is set by means of a hex nut on the adaptor body.

To order the mounting you need, write the related code number (see the table below) in the proper position in the part number.

Hard-mounted adaptors are used for 1/2 and 5/8 lenses and 3/4 inch round. "Snap-in" adaptors are used for lenses of 3/4 inch or larger.

LENS SIZE	CODE
1/2 inch round (L12, L15)	22
1/2 inch square (L1, L7)	21
5/8 inch round (L13)	62
5/8 inch square (L2, L6)	61
3/4 inch round (L14)	52
3/4 inch round (L14)	51 <sup>1</sup>
3/4 inch square (L3)	31 <sup>1</sup>
1 x 3/4 inch (L4)	41 <sup>1</sup>

<sup>1</sup> snap-in adaptors

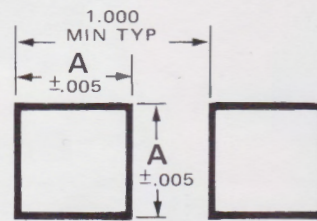
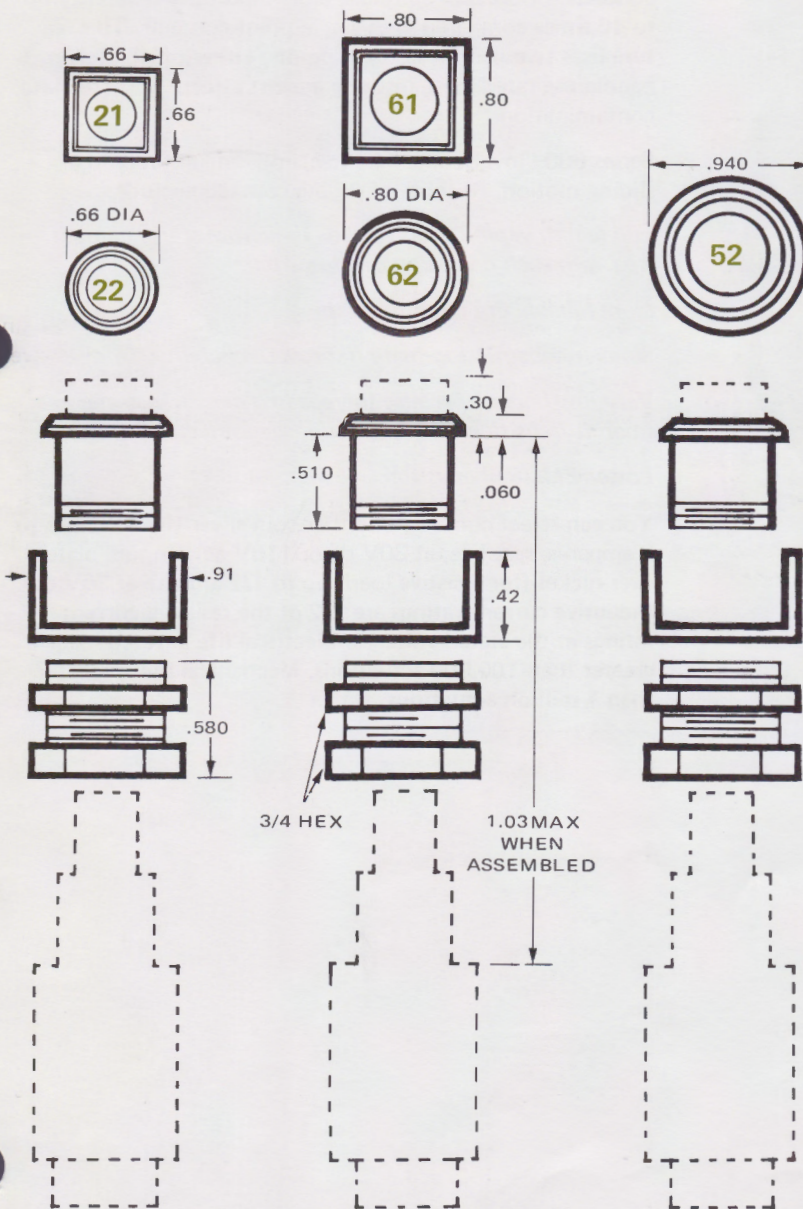

PANEL CUTOUT (REF.) FOR SQUARE ADAPTORS

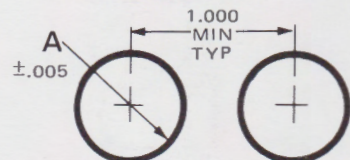

PANEL CUTOUT (REF.) FOR ROUND ADAPTORS

PART NUMBER	"A" DIMENSION
(21) square	.570
(61) square	.726
(22) round	.570 DIA
(62) round	.726 DIA
(52) round	.851 DIA



MSC<sup>®</sup>

306



Even though Series 600 switches are low-cost, computer-grade units, they make no compromise with reliability. Reliability is the quality that gives you confidence in your own product – and the competitive edge.

### SLIDING CONTACT DESIGN

Switches for loads up to 2 amperes use sliding, bifurcated contacts. Bifurcated contacts, alone, multiply reliability up to 40 times compared with single-point contacts. This feature uses two parallel contact points, either of which can handle the rated load, insuring against effects of particulate contamination.

Series 600 “low-bounce” contacts operate entirely in a sliding motion. Benefits of sliding contacts include:

*Full-length wiping action cleans the entire active contact area with each operation of the switch.*

*More reliable dry circuit switching.*

*Simpler construction, with improved reliability.*

*Very low bounce because there is low mass transfer, and a smooth transition from insulation to contact.*

*Lower EMI/RFI emission.*

You can select contacts of either coin silver (for loads up to 2 amperes, resistive, at 30V dc or 115V ac); or gold plate over nickel (for resistive loads up to 1/2 ampere at 30V dc). Inductive current ratings are 1/2 of the resistive current ratings at the stated voltages. Electrical life at rated loads is greater than 100,000 actuations. Mechanical life is greater than 1 million actuations.

Note: Switches shown on pages 6 & 7 are in clear housings for visibility of internal mechanism



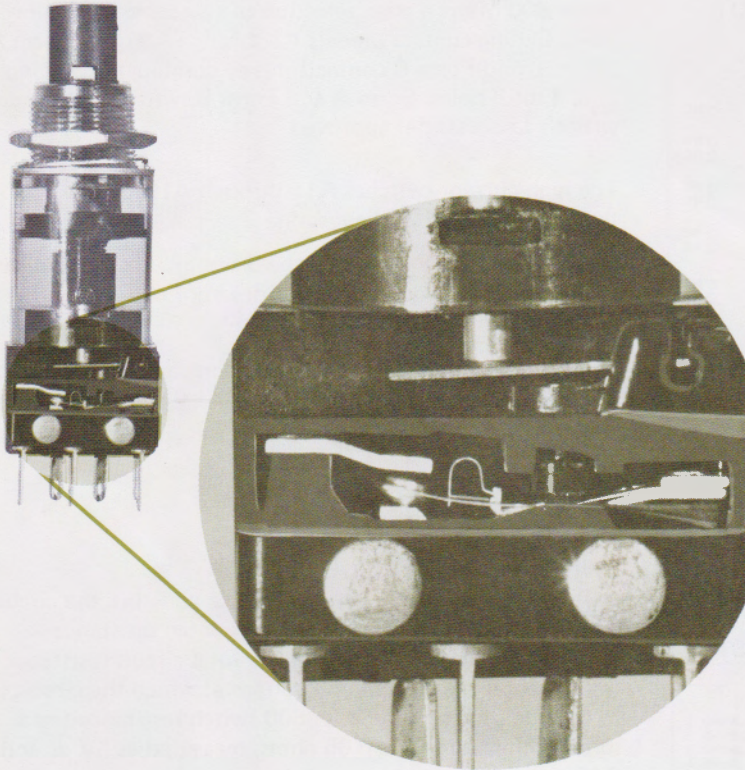

**SNAP-ACTION CONTACTS**

Series 600 switches rated at 5 or 10 amperes use long-life snap-action contacts. All 5- and 10-ampere switches are furnished in a two-pole, Form C configuration. Electrical and mechanical life is greater than 100,000 actuations at maximum rated load.

**SWITCH ACTION**

Series 600 gives you a broad choice of actions. The different actions are described in the table below. To specify the switch contacts and actions, write in the part number the code you select from the table. For your special requirements, call the factory and MSC will help you with the switch you need.

**GOLD**

- A1
- A2
- A3
- A4

**SILVER**

- A5 momentary, silent
- A6 momentary, tactile feel
- A7 alternate action
- A8 indicating alternate (pushbutton remains depressed .100 in the "on" state, and is released when pressed to the "off" state)
  
- A11 5 ampere, momentary, silent
- A12 5 ampere, momentary, tactile feel
- A13 5 ampere, alternate action
- A14 5 ampere, indicating alternate
- A15 10 ampere, momentary, silent
- A16 10 ampere, momentary, tactile feel
- A17 10 ampere, alternate action
- A18 10 ampere, indicating alternate

**A20 and A21**

Indicator only, extended body to match PC board-to-panel dimensions of switches

Standard actuating force on the sliding-contact switches is 16 to 32 ounces. To order a special low-actuating-force switch (14 to 22 ounces), insert the code **XI** following the series identifier 600 in the part number. For example:

**600X1 31 A1 . . . ETC.**

The low-actuating-force option is available in configurations C1, C2, C11, C12, C21, C22, and C23 (see page 8).

Actuating force for the 5- and 10-ampere switches is 32 to 48 ounces.

Plunger travel for Series 600 switches is 0.200±0.02 inch.





**"LOW BOUNCE" SWITCH CIRCUITS  
FORM "C" CONTACT ARRANGEMENTS**

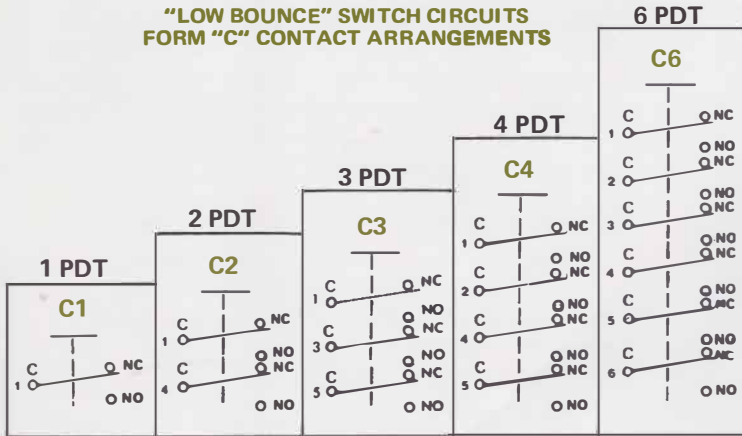

**2 PDT**

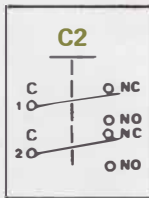

**"SNAP-ACTION" SWITCH CIRCUITS  
FORM "C" CONTACT ARRANGEMENTS**

**"LOW BOUNCE" SWITCH CIRCUITS  
FORM "A" & "B" CONTACT ARRANGEMENTS**

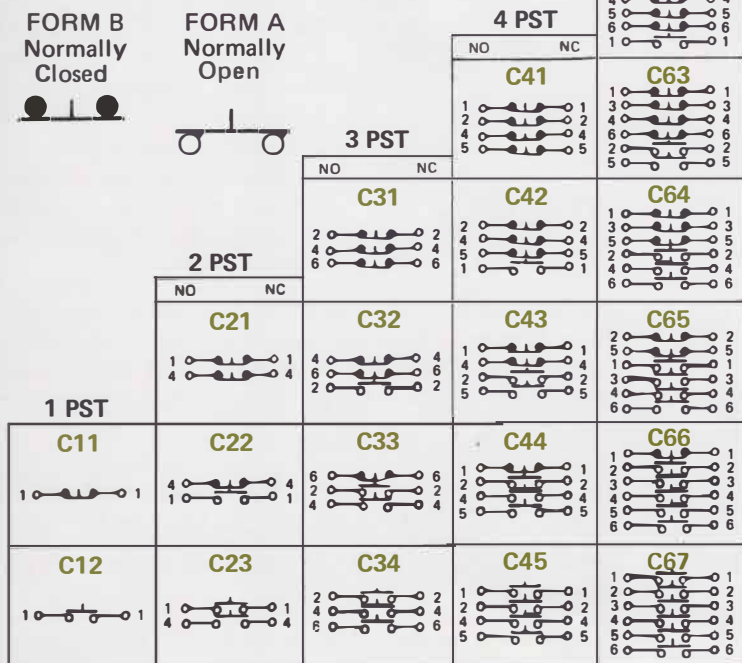
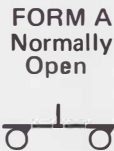

Series 600 offers a great selection of switching configurations. Sliding-contact models A1 through A8 offer Form A, Form B, and Form C contacts in any combination having 1, 2, 3, 4, or 6 poles. Form A and Form B switches are Underwriter's Laboratories approved.

The high-current switches A11 through A18 are always in a two-pole, Form C configuration.

Ordering codes are shown on the diagrams. Just add to the part number the code that identifies your chosen contact arrangement.

Omit the circuit configuration code indicator-only units (A21). The code for switches A11 through A18 is always C2.

**SWITCH RESISTANCE**

Switch resistance is the total resistance added to the circuit by the switch. In most applications, switch resistance should not exceed 1 percent of the total circuit resistance (measured at the current and voltage at which the circuit is to operate). Maximum Series 600 switch resistance (measured at the factory) is 0.05 ohms, measured at 6V dc and 0.10 amperes.

**CONTACT BOUNCE**

Contact bounce is important to the user only in high-speed circuits where bounce can appear as repetitive activations. Any mechanical switch exhibits bounce. A snap-action switch bounces because of the momentum of the common contact. A slide-action switch bounces only very slightly, because moving contacts have little momentum as they move from insulation to contact material. Bounce in this case is minimized by a very smooth mechanical transition as the moving contact moves onto the fixed contact. The bounce period of a Series 600 2-ampere (momentary switch), as it leaves the factory, is under 1 millisecond.

If the switch handles a relatively large load, the transition point on the contact will eventually be degraded, increasing the bounce period. In low-load applications, however, the bounce characteristic will change very little from its original value.



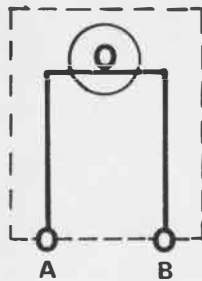

**LAMP CIRCUIT**

On every Series 600 unit, the lamp circuit is completely independent of the switch circuit. Lamp terminals are marked A and B. Polarity is important only when an LED lamp is used. For LED's, terminal B is always positive.

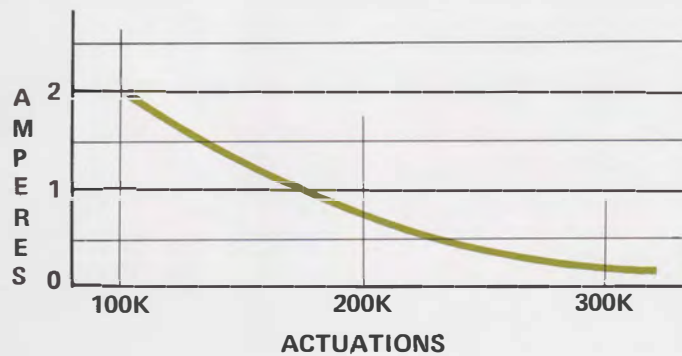

**LIFE VS. LOAD**

(resistive load, 28V dc)

Series 600 2-ampere switches will switch maximum rated loads for 100,000 actuations with a 98% confidence level. The curve shows expected life at lower loads. For loads greater than 2 amps., the Snap Action Contact Unit A11 thru A18 should be used.



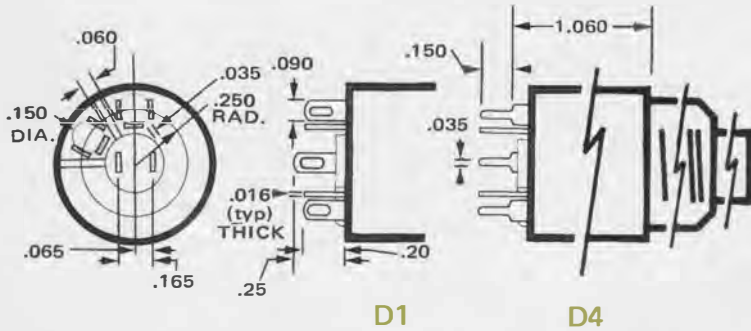

D1 D4  
LOW BOUNCE SWITCH TERMINATIONS

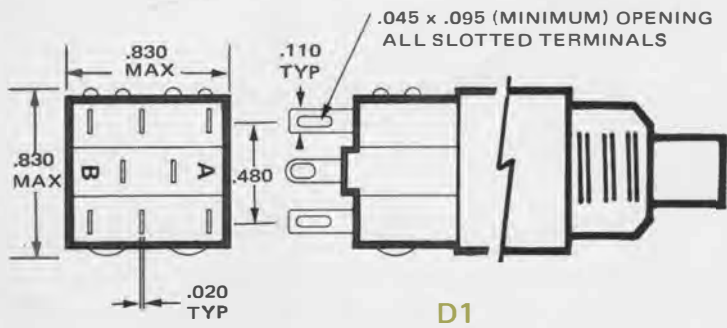

D1  
SNAP-ACTION SWITCH TERMINATIONS

Series 600 offers your choice of either pierced solder-lug terminals, or pin terminals for direct mounting on printed circuit boards. Considerable cost savings can be gained by mounting switches directly on the circuit board.

The drawings show terminal arrangements and dimensions. For pin terminals, drill the circuit board holes  $0.050^{+0.003}_{-0.000}$  inch. Pierced solder lugs on the 5- and 10-ampere switches will accommodate AMP 110 Faston quick-connect receptacles.

To select the terminal type, write the related code in the proper place in the part number. Codes are:

TYPE	CODE
Solder lug (A1-A8, A11-A21) . . . . .	D1
Printed-circuit terminals (A1-A8) . . . . .	D4

**TOLERANCES**

- .XX ± .03
- .XXX ± .010

**WIRE SIZE**

Terminals will accommodate 2 no. 20 wire.



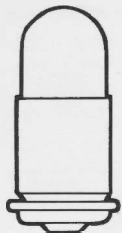

F1 F2 F3 F14



F4 F10

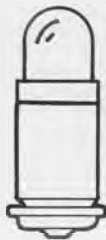

F5 LED

A Series 600 lens will accommodate any commercially available T 1-3/4 midget flanged-base lamp. These lamps are stocked by both our factory and MSC distributors and can be delivered immediately. All lamps can be easily replaced from the front of the switch without special tools.

Incandescent, neon, and LED lamps are available from stock. LED lamps can be selected for extremely long life, but offer less brightness. Special lenses are used with LED lamps (see page 12).

Available lamps are listed below. To order the lamp you need, write the corresponding code in the proper place in the part number.

TYPE	VOLTS	LIFE (HRS)	CODE
Incandescent	6V dc	1000	F1
Incandescent	12V dc	1500 at 14V	F2
Incandescent	28V dc	4000	F3
Incandescent	28V dc	7000	F14
Neon	115V ac	(Note 1)	F10
Neon	115V ac	1000 (Note 2)	F4
LED (red)	5V dc	10 <sup>4</sup> min (Note 3)	F5

<sup>1</sup> external resistor required (life determined by resistor).  
<sup>2</sup> lamp has internal resistor.  
<sup>3</sup> lamp has internal 150-ohm resistor.

- (A) AMBER
- (B) BLUE
- (R) RED
- (G) GREEN
- (Y) YELLOW
- (W) WHITE

Six translucent colors are available for various indications. Each color is vivid and distinctly different from the others.

Lens colors have been selected following human-engineering and optical response studies, as well as MSC's experience and field surveys. Some suggestions are:

*Use blue and green in dimly lighted areas.*

*Use a neutral-colored panel area.*

*For LED lamps, use only the lenses specified for that purpose.*

For neon lamps, use only RED or AMBER lenses

To indicate the lens color in your part number, write the initial letter of the selected color (in parentheses) following J1. (See page 12 for engraving details.)



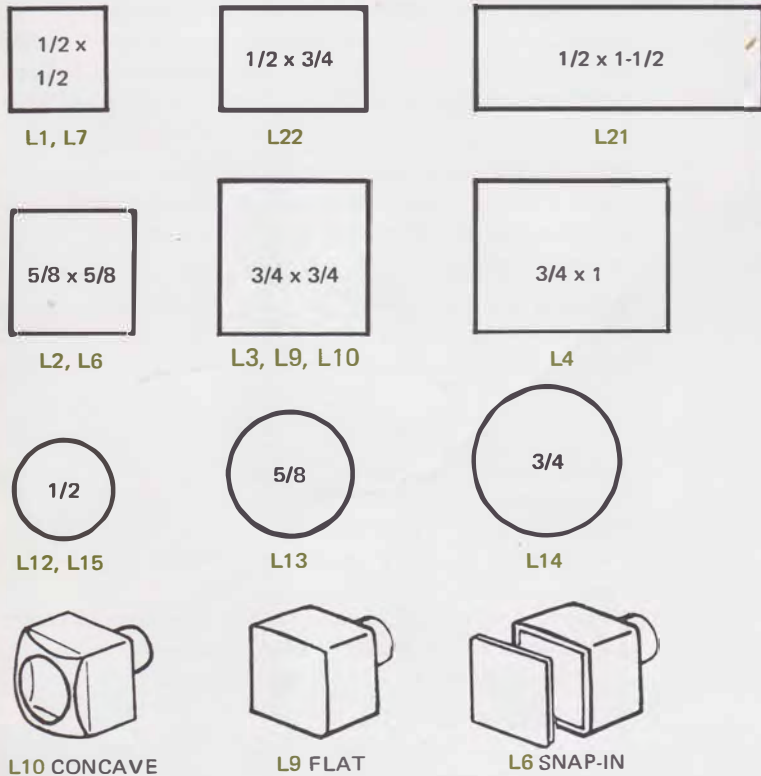

Series 600 lenses are made of tough, abrasion-resistant Lexan. Lenses are translucent, but diffuse the internal light so that the lamp filament is not visible through the lens.

Select the size and shape of the lens considering space available on your panel, esthetics, and the legend to be engraved. The drawings show the lens sizes and shapes available. Check with our factory for special size and shape requirements.

Styles L7 and L15 are special transparent red lenses for use with LED indicators. These lenses have a serrated dome for maximum light dispersion and do not bear a legend.

Lens L6 permits changing the legend. A transparent snap-in front can be removed in order to install a film insert bearing the desired legend (see illustration).

To help you to remove the lens from the switch, the lens has fingernail grooves molded in two sides. Lens retention force is 3 pounds ± 2 pounds.

To order the lens you need, simply write down the corresponding code. For example, to order a round, half-inch lens, write L12 in the proper position in the part number.

60031A5C2DIF3J1(A)L3N12ON

ENGRAVING

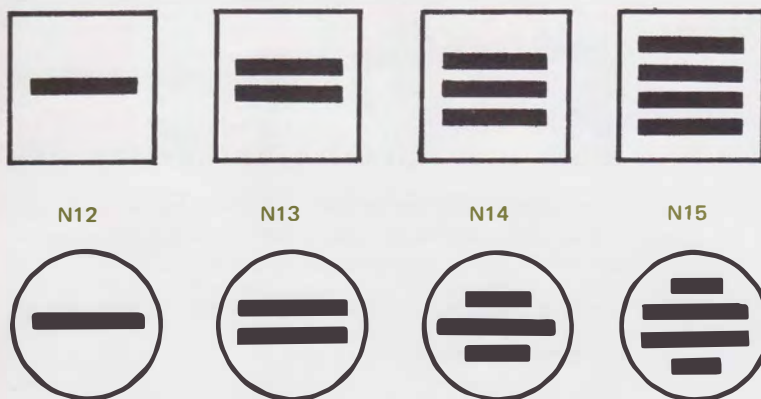

To assure permanent and sharp-looking pushbuttons, legends are front-engraved and filled with a special high-durability filler. For easy visibility, the filler color is black for amber, white, and yellow lenses; and white for red, blue, and green lenses. The selection of these combinations is based on optical-response studies and field experience. Consult the factory for other filler colors and combinations.

The standard character style is New Hermes Condensed Block. Standard character height is 0.10 inch, and standard stroke is 0.017 inch. Please ask the factory about special character requirements.

The diagrams show the different line configurations available on both the square and the round lenses. The table shows the maximum number of lines and characters you can have on any lens size and style.

To order the legend you need, write the corresponding code, followed by the actual legend you want to appear on the lens. For example, to order the words DC POWER, on two lines, write N13 DC, \* POWER to complete the part number.

\* comma means another line of engraving

LENS SIZE & SHAPE	NUMBER OF LINES	CHARACTERS PER LINE
L1	2	4
L2	3	6
L3	4	7
L4	4	10
L6	3	6
L7	0	0
L12	2	4
L13	3	3-6-3
L14	4	3-7-7-3
L15	0	0
L21	2	15
L22	2	7



# GANGED ASSEMBLIES INTERLOCKING ASSEMBLIES; FRONT PANEL MOUNT WITH CHROME BARRIERS

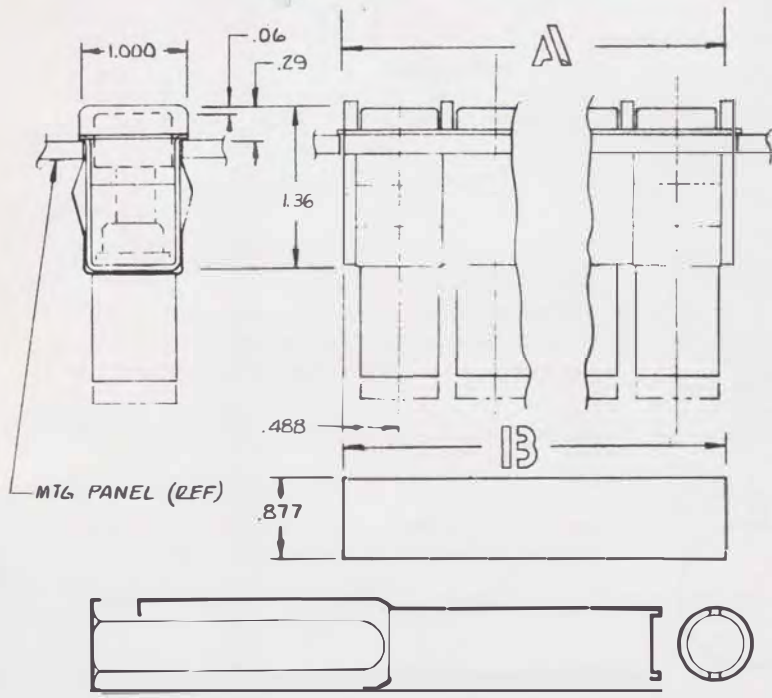
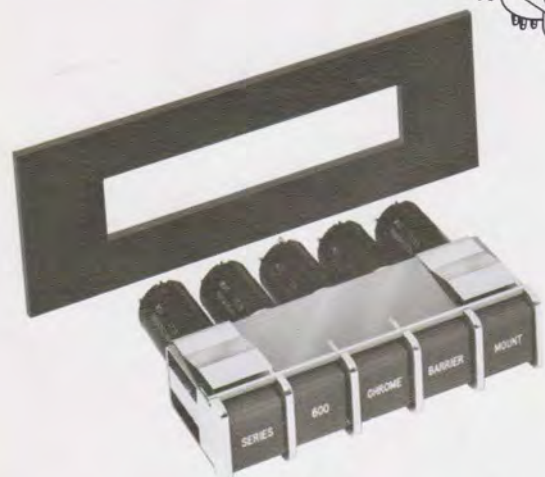
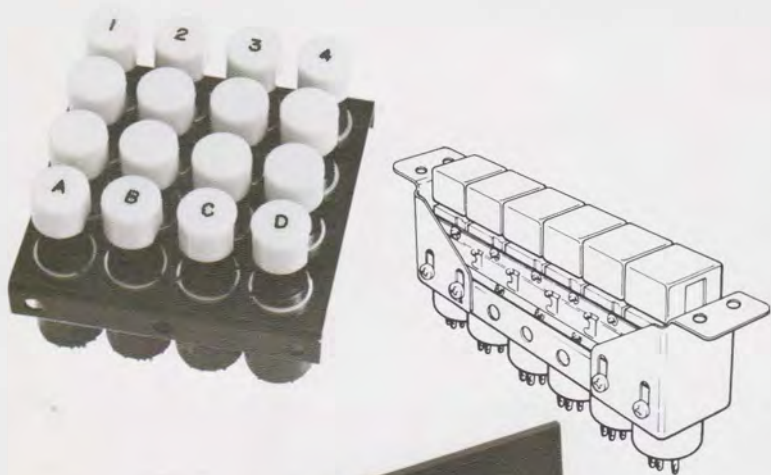

Any types of Series 600 switches can be assembled on sub-panels to facilitate your manufacturing or assembly operation. These units are available in single rows or in matrices.

You can order Series 600 switches in in-line assemblies of from two to fifteen interlocked switches. These assemblies operate in such a manner that only one switch can be "on" at a time. Pressing any switch "on" returns any other switch to the "off" state.

Interlocked switches are on 3/4-inch centers and may be used with any lenses not wider than 3/4 inch. All switch actions in an interlocked assembly are momentary, silent. Any Series 600 circuit configurations may be used.

Ask the factory, or your MSC representative, for help in specifying your ganged or interlocked switch assemblies. Use pin 600-N □ or 600-M □ followed by part number of unit in the assembly.

Chrome-plated barrier assemblies are available to mount horizontal or vertical rows of Series 600 units. These assemblies mount through the panel front and provide an attractive panel design with barrier protection between switches to prevent inadvertent depression of two switches simultaneously.

Use part number "P" followed by the number of units in the assembly. This code number for barrier mount is inserted in the part number between the Series number and the switch contact and action call out.

CH	A	B	CH	A	B	CH	A	B
1	0.976	0.991	6	5.351	5.366	11	9.726	9.741
2	1.851	1.866	7	6.226	6.241	12	10.601	10.616
3	2.726	2.741	8	7.101	7.116	13	11.476	11.491
4	3.601	3.616	9	7.976	7.991	14	12.351	12.366
5	4.476	4.491	10	8.851	8.866	15	13.226	13.241

## SPANNER WRENCH

A Series 600 switch ordered without a mounting adaptor is furnished with a spanner nut, lock washer, and indexing washer. A Model 600-PT-01 Spanner Wrench should be used to facilitate installation of the switch



"LOW-BOUNCE" SWITCH



"SNAP ACTION" SWITCH

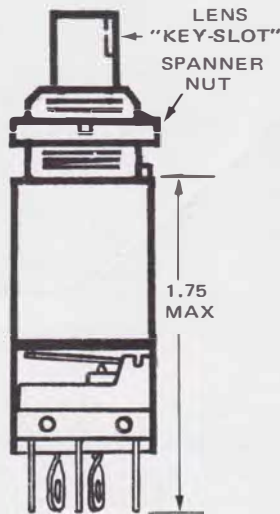
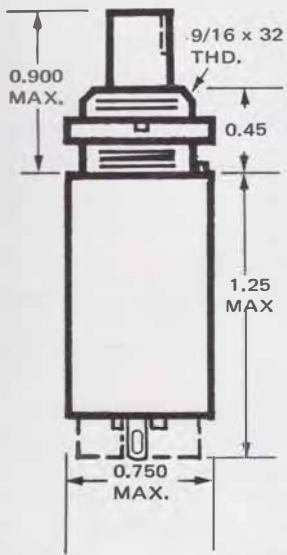

LAMP CAPSULE/BUTTON ASSY.

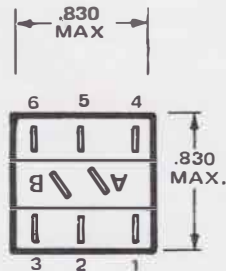
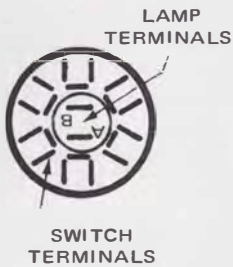
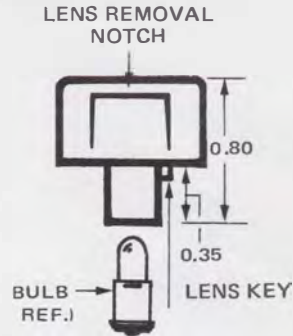

The drawings show dimensions of the basic Series 600 units. The behind-panel length of a complete flush-mounted unit is equal to the length of the adapter (see pages 4 and 5), plus the length of the basic switch body and terminals.

TOLERANCES

- .XX ± .03
- .XXX ± .010

PANEL CUTOUT

The drawings show the cut-out required in the panel to accommodate the basic switch. Cut-outs required for adapter mounts are shown on pages 4 and 5.

NOTE: All parts of the Series 600 units are "keyed" to the panel cutout for proper alignment. The lens has a key slot that aligns with a key slot on the switch plunger. There is a panel index key on the switch housing that aligns with a key slot in the panel cutout. It is important that all of these key slots align on the same side of the switch unit.

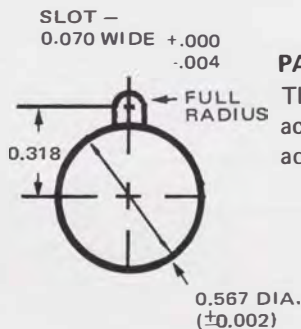



# 60031A5C2D1F3J1(A)L3N12ON

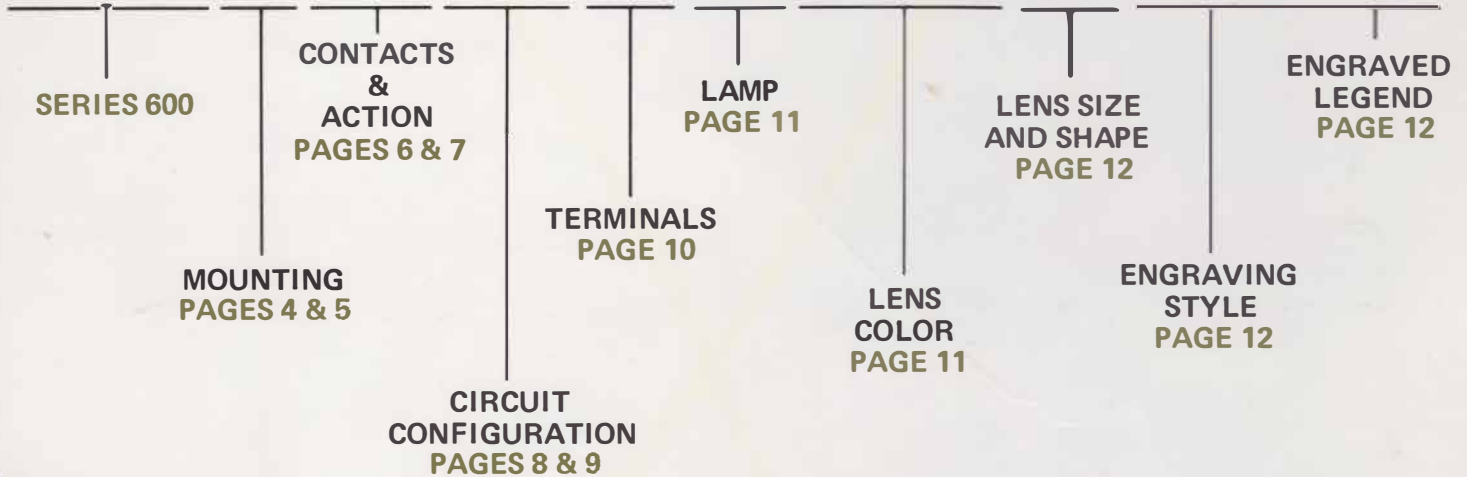

While you specified the different features you want for your Series 600 switch, page by page through this catalog, the part number was assembled.

The part number should contain all elements (except the circuit configuration code should be omitted if an indicator only unit has been selected).

Check each element of the part number to make sure you have made no error.

Now call the factory or your MSC representative and place your order.